



MED

MINE EXTRACTION DEVICE



Available in 210 and 360 tonne rated capacities

Elphinstone Mine Extraction Device (MED)
elphinstone.com

ELPHINSTONE

UNDERGROUND RELIABILITY



ELIMINATES UNSAFE EXTRACTIONS

Use fit-for-purpose equipment during extractions

The Elphinstone Mine Extraction Device (MED) has been designed, manufactured and engineer certified with a pulling capacity of up to 360 Tonnes.

The Mine Extraction Device was invented in response to requests from underground miners having difficulties extracting buried equipment without damaging the mine or negatively impacting production.

The MED has performed hundreds of successful extractions at a number of underground mining operations (both coal and hard rock) across Australia and internationally.

Minimises disruptions to mining operations

Production disruptions are minimised by eliminating the need to deploy production equipment to assist in recoveries as well as minimising interactions with bogged or buried equipment.

The MED eliminates the need for traditional recovery methods that involve the use of other mobile equipment,

which reduces the hazards associated with personnel working around mobile equipment in close quarters and allows other mining operations to continue relatively uninterrupted.

What makes the MED so unique?

The Mine Extraction Device does not rely on traction like other systems. After the MED is towed into position, the wheels are raised to lower the MED to the ground and the boom is then raised against the roof. A bridle is interlocked onto the teeth of the MED racks. These MED racks are then pulled via hydraulic cylinders.

This is in contrast to using wheeled or tracked tow vehicles that can result in damage to the machines, the mine infrastructure, all of which can add further delays to the restart of production.

Insurance supports the proven MED system

The unique retrieval system has the support of numerous insurance companies with the recognition that if this system cannot retrieve a buried loader then the loader is not retrievable.



PULLER CAPABILITIES & SPECIFICATIONS

Two powerful and dynamic levels of pulling capacity

The Mine Extraction Device is available in 210-tonne, and 360-tonne capacities, developed in line with industry growth. (Older configurations still supported).

In addition to the retrieval of buried equipment, the higher capacity models are also capable of extracting drill rods embedded in the rock face.

Features Include:

- » Pulling capacity of up to 360 Tonnes.
- » The extendable boom allows use in a range of underground operations.
- » Easily towed into place.
- » Operating pressure (Max) 180 Bar, flow rate of 40-90 litres per minute.
- » Control pedestal and pilot valve.
- » Optional remote control.
- » Winch to assist in machine and rack positioning.
- » Cranes to assist positioning racks (MED360 only).





STANDARD AND OPTIONAL EQUIPMENT

● Standard ● Optional

Description	Qty	MED210	MED360
Arm Lift Cylinder Safety Lock	1	●	●
Base Machine	1	●	●
Boom Extension, 4m (13.1 ft)	1	●	●
Boom Extension, 5m (16.4 ft)	1	●	●
Boom Extension, 6m (19.6 ft)	1	●	●
Connecting Link	1	●	●
Recovery Hardware Kit	1	●	●
Control Bank	1	●	●
Head Plate, Flat	1	●	●
Head Plate, Curved	1	●	●
Hose Storage Rack	1	●	●
Hydraulic Hoses, Machine to Control Bank	10m /32ft 9.6in	●	●
Hydraulic Hoses, Control Bank to Power Pack	10m/ 32ft 9.6in	●	●
Hydraulic Power Pack	1	●	●
Hydraulic Winch	1	●	●
Rack	10	●	●
Rack Pin	10	●	●
Rack, Transport box, MED210	1	●	
Rack, Transport box, MED360	2		●
Rack, Lifting Tool	1	●	●
Shipping Container, 20 foot	1	●	
Shipping Container, 20 foot	2	●	●
Tow Bar	1	●	●
Operation		MED210	MED360
Operating Pressure (Max)		180 bar	180 bar
Operating Flow Rate		40-90 L/min	40-90 L/min

Diagram for reference purposes only

Model pictured: MED210

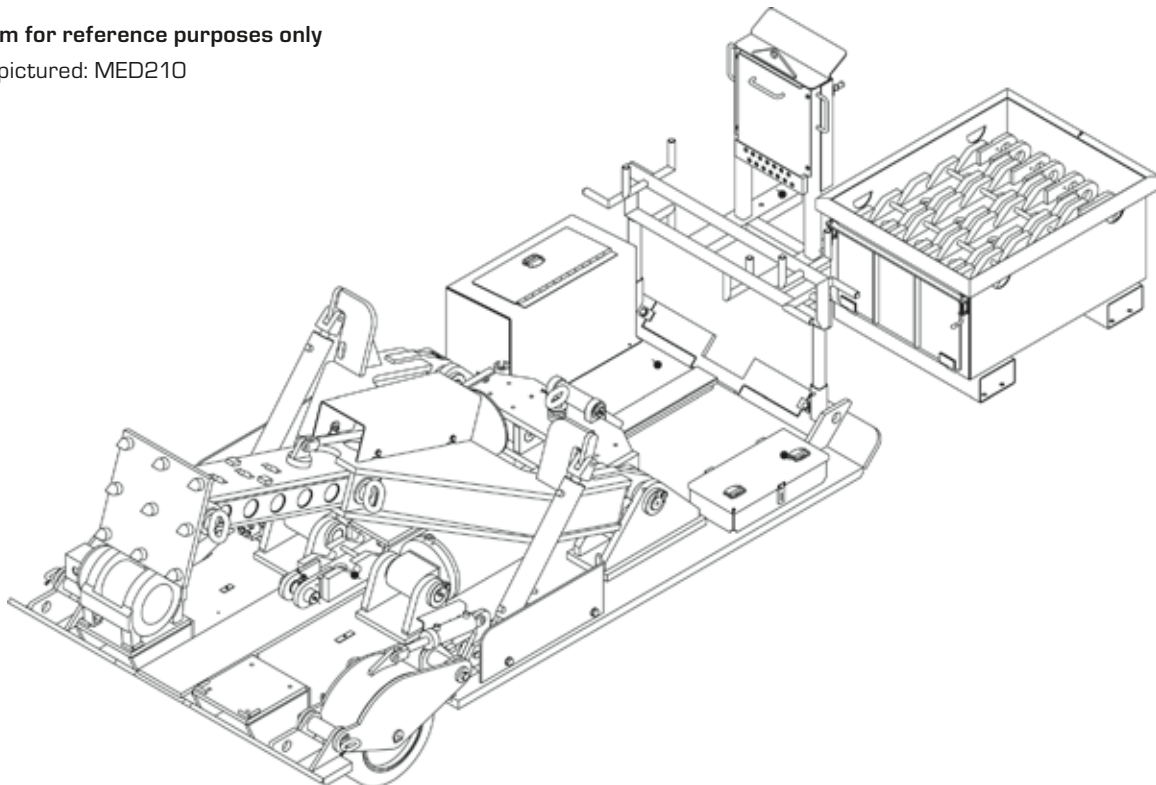



MACHINE DIMENSIONS

Diagram for Reference Purposes Only

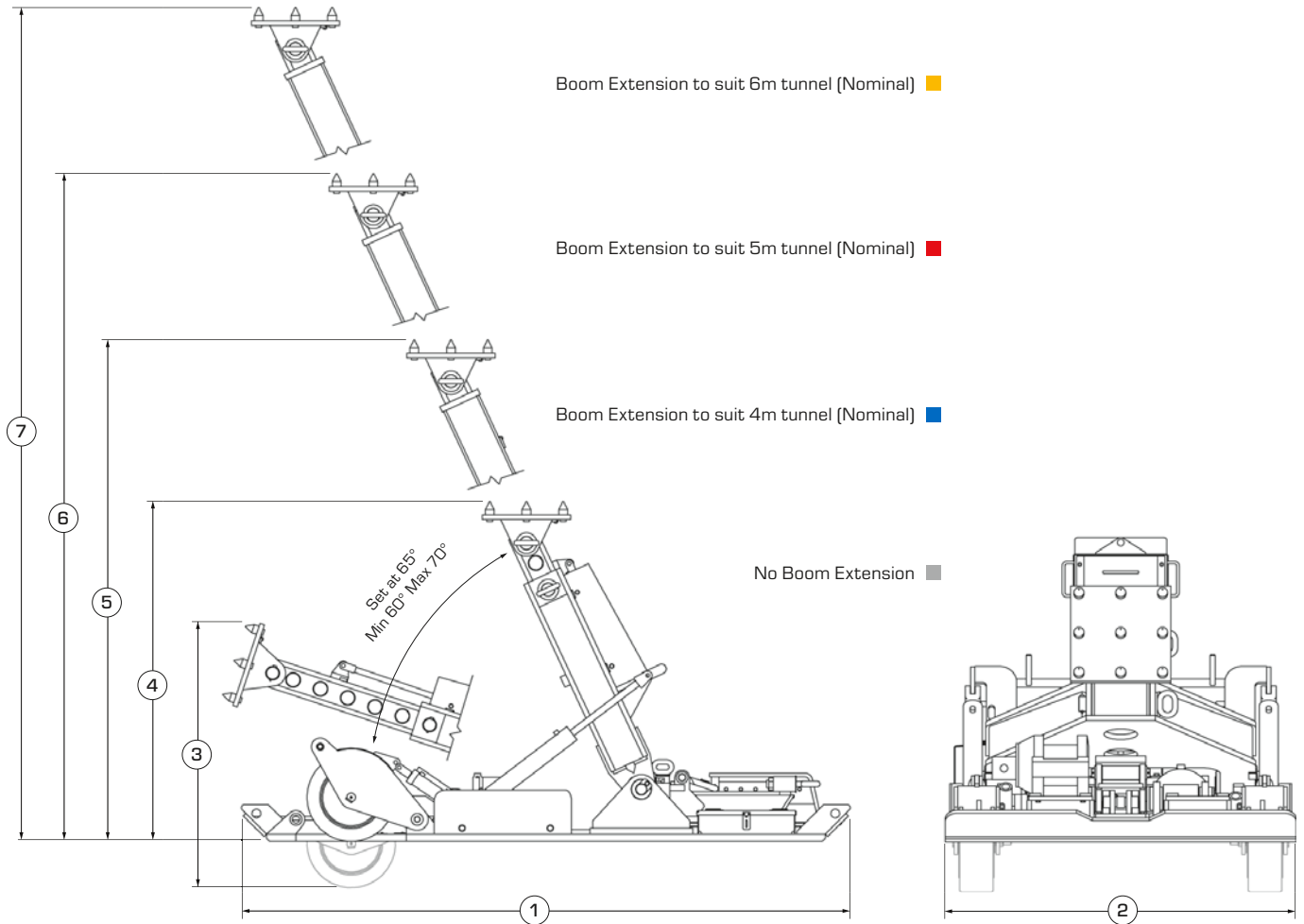

Dimensions

	MED210		MED360	
1 Length	4142 mm	13 ft 7.1 in	4720 mm	15 ft 5.8 in
2 Width	2100 mm	6 ft 10.6 in	2300 mm	7 ft 6.9 in
3 Height - Ground to Head Plate - Retracted for Transport	1830 mm	6 ft	1940 mm	6 ft 4.4 in
4 Height - Retracted (No Boom Extension)	2320 mm	7 ft 7.3 in	2780 mm	9 ft 1.4 in
	3030 mm	9 ft 11.2 in	3500 mm	12 ft 5.8 in
5 Height - Retracted with Standard 4m Boom Extension (13.1 ft)	3430 mm	11 ft 3.0 in	3470 mm	11 ft 4.6 in
	4100 mm	13 ft 5.4 in	4460 mm	14 ft 7.6 in
6 Height - Retracted with Standard 5m Boom Extension (16.4 ft)	4400 mm	14 ft 5.2 in	4420 mm	14 ft 6.0 in
	5150 mm	16 ft 10.8 in	5470 mm	17 ft 11.4 in
7 Height - Retracted with Standard 6m Boom Extension (19 ft 8.2 in)	5350 mm	17 ft 6.6 in	5060 mm	16 ft 7.2 in
	6150 mm	20 ft 2.1 in	6140 mm	20 ft 1.7 in
Height - Ground to HIAB Crane Knuckle (Packed Up - MED360 only)	N/A		2195 mm	7 ft 2.4 in

Weights

	MED210		MED360	
Machine Total Mass*	9260 kg	20414.8 lb	16,500 kg	36376.3 lb
Rack	103 kg	227 lb	270 kg	595.2 lb
Rack Pin	6 kg	13.2 lb	11 kg	24.3 lb
Rack Box	325 kg	716.5 lb	660 kg	1455 lb

*Total mass excludes vendor parts

OVER 50 YEARS IN THE MINING INDUSTRY.

Elphinstone Pty Ltd is an established Caterpillar OEM Solutions customer with over 50 years' experience in the mining industry.

Elphinstone specialises in the design, manufacture and support of quality equipment for the global underground and surface mining industries.

The Elphinstone range of products combines practical design, the latest technology and quality manufacturing to ensure reliable performance.

The current product range includes specialised underground support vehicles, mine extraction devices, extended distance off-highway haulage trucks and water tanks designed to fit Caterpillar 740C, 745C and 745 articulated trucks.

All Elphinstone products, technical assistance, support, and access to spare parts are available through the global Cat® dealer network with additional support from the Elphinstone regional sales and support team.

MINE EXTRACTION DEVICE

For more complete information on Elphinstone products, dealer services, and industry solutions, visit www.elphinstone.com or contact your local Cat® dealer.

Material and specifications are subject to change without notice. Featured machines in photos may include additional equipment.

Elphinstone and their respective logos, as well as corporate and product identity used herein, are trademarks of Elphinstone and may not be used without permission.

© 2026 Elphinstone. All rights reserved.
Made in Australia for export.

ELPHINSTONE



HM62782-12 (05-2026)