

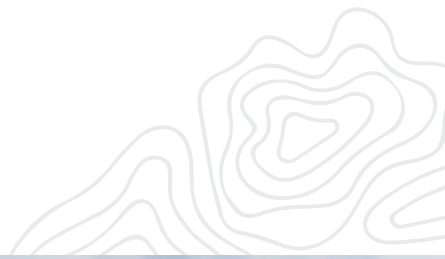

# E15

**DELIVERY WITH CRANE**



Elphinstone Underground Support Solutions  
[elphinstone.com](http://elphinstone.com)

**ELPHINSTONE**

**UNDERGROUND RELIABILITY**



**E15 DELIVERY**  
WITH CRANE





# DELIVERS ON RIDE, MANOEUVRABILITY, AND PAYLOAD.

## Reliability and performance in harsh conditions

The E15 Delivery with Crane is the second model in the series to be released, adding another application to the expanding range of E15 Underground Hard Rock Support Vehicles.

## Operator safety

With safety as a priority, the E15 is engineered with onboard machine diagnostics for rapid fault identification, increasing the availability and productivity of the machine.

The certified ROPS/FOPS air-conditioned operator cabin seats three persons comfortably. The ergonomic controls, central driving position, excellent 180 degree view, and LED lighting increase safety and reduce operator fatigue.

The oscillating hitch, nitrogen-charged front suspension (optional) and air-ride seats provide unrivalled comfort for the operator. The electromagnetic braking retarder, adjustable from the operator's seat, provides superior and reliable braking capability.

Safety features include emergency crane stops located on the manual control station, a wireless joystick remote, programmed exclusion zones, manually adjusted stabilising legs with levelling sensors, and easy pack-up for safe transit.

## Maintenance and Serviceability

All service points such as tanks, filters, lubrication points and compartment drains are conveniently located at ground level for servicing.

## Machine Application

A flexible transport solution with lift on or lift off capability ideal for moving parts, components, equipment, and maintenance personnel safely and securely throughout the mine site. The large flat deck has the capacity to fit 6 standard size pallets, and a maximum capacity of 16,620 kg.

## Contents

Structures, Work Tools and Attachments	4
Operator Environment	6
Safety Features	7
Engine	8
Powertrain	9
Product Features	10
Customer Support	12
Maintenance and Serviceability	12
Sustainability	13
Technical Specifications	14
Machine Dimensions	15
Standard and Optional Equipment	16



## **SAFE AND EFFECTIVE LOAD HANDLING AND MAXIMUM PAYLOAD UPTO 16,620 KG.**

### **Machine application**

- » Flexible transport solution with lift on or lift off capacity.
- » Transports parts, components, equipment, and maintenance personnel safely and securely throughout the mine site.
- » Large flat deck features a maximum payload of upto 16,620 kg plus the capacity to fit 6 standard size pallets.
- » Excellent top speed at full capacity.

### **Safe and effective load handling**

The fully integrated Hiab X-HiDuo 092 crane features a rated lifting capacity of 8.8-tonne metre (TM) and a 7.7-metre outreach, providing an impressive and reliable solution for day-to-day heavy lifting.

- » Rated lift capacity of 8.8 TM.
- » Crane outreach 7.7 m.
- » Automatic crane pack up.
- » Crane controlled with manual lever or wireless joystick remote.
- » Stabiliser legs with levelling sensors manually pivot and extend.
- » Pre-programmed exclusion zones.

### **Impressive payload**

The 4.5m by 2.5m deck features a steel tread plate floor bordered by multiple tie-down points and provision for ratchet load binders. Dual-sided three-point access with high-visibility



green handrails is enhanced with a cleverly designed optional removable guard rail system with onboard storage.

### **Optional front and rear hydraulic jack legs**

Optional front and rear jacks can be fitted. The front jacks have a park function to allow the operator to safely exit the cabin with machine running. The rear jacks provide stability when mixing and to raise the machine for discharge. All jacks can be utilised to raise the machine off the ground while changing tyres.

### **Optional features:**

- » Air-ride seats for the operator are standard and optional for passengers.
- » Front and rear hydraulic jack legs.
- » Optional in-cab filtration complying with ISO 23875.
- » Optional partial-flow DPF can be fitted in place of standard muffler on Tier 3 models.
- » An air-cooled compartment for lunch box storage, cupholders and phone charging ports.
- » Ratchet load binders.
- » Hydraulically filled nitrogen-charged suspension cylinders.



## **STRENGTH AND SUPERIOR BRAKING PERFORMANCE.**

### **High-capacity Electromagnetic retarder**

Fitted to the rear frame, the electronically controlled retarder provides superior braking performance on grade, featuring diagnostic capabilities with alarm and fault conditions reported back to the operator display.

The integrated Retarder Control System (iRCS) combines both the control and power functions into a single unit. The innovative electronic design significantly reduces the retarder's energy consumption, preserving electric circuits.

The retarder, factory set with a percentage of retardation, is controlled via an integrated multi-function joystick controller located on the operator's right-side armrest.

The intelligent grade-sensing electronic 'speed control' utilises the high-capacity retarder, engine speed, and the correct transmission gear to control speed while descending into the mine, hence reducing wear and tear on the service breaks, parts and components.

### **Oscillating hitch**

The oscillating hitch provides superior operator comfort, 4-wheel ground contact and reduced wear on the hitch and steering components. Includes a heavy duty deep frame section through oscillating hitch area with +/- 42.5° steering articulation and +/- 10° oscillation.

### **Heavy duty front frame**

The robust, heavy-duty, and purpose design front frame utilises a high tensile steel construction with an average plate thickness of 20mm (0.80in). The frame design is common to both E15 front and E10 centre-mounted operator cabin options, both engine options and the option of front suspension or rigid axle.

The front suspension mounting points and fuel tank are incorporated into the common frame. The frame includes an access cover for cleaning and inspecting the fuel tank if required.

### **Common rear frame**

The E15 rear frame uses high tensile steel box section construction with an average thickness of 12mm (0.47in).



## COMFORTABLE AND EASY TO OPERATE.

### Front mounted cab with 180 degree view

The E15 features an air-conditioned, 3-seat enclosed cabin (pictured above). The enclosed cabin features ergonomics for operator comfort, user-friendly intuitive controls, and excellent 180-degree view.

The cabin includes the following features:

- » Front-mounted to machine.
- » ROPS/FOPS certified design.
- » 300mm (12in) touch screen operator display.
- » Fingertip controls mounted to operators seat.
- » 3 full size seats. Air-ride suspension seat standard for driver, non-suspended seats for occupants. Optional Air-ride suspension seats for all persons.
- » Air conditioning and cab pressurisation.
- » Air-cooled compartment for lunch box storage, cupholders and smartphone charging ports.
- » Seat belts with occupant detection systems on operator seat.
- » Emergency stop inside cab.

### Integrated multi-function joystick controller

The operator's right arm rest features an integrated multi-function joystick controller providing finite control in transit for agitator speed and adjustment of retardation braking.

### Transmission controls

The keypad transmission control is conveniently located near the operator's right hand, with forward and reverse gears changed effortlessly with finger touch accuracy reducing driver fatigue.

### High level of operator comfort

The A-frame front axle suspension, oscillating hitch, and air-suspended seats deliver a high level of machine comfort to the operator and passengers.

The oscillating hitch ensures 4-wheel ground contact and reduced wear on the hitch and steering components. Nitrogen-charged hydraulic suspension cylinders and A-frame provide superior front axle ride quality over rough terrain.

### Touch screen operator display

The 300mm (12in) touch screen displays vital machine status information. Data collected includes engine coolant and transmission oil temperature, pitch and roll indicators, engine oil pressure, engine speed, an integrated camera system (up to 4x), and vehicle speed and fuel level.

### Advanced Machine Diagnostics

Elphinstone's advanced onboard machine diagnostics system continuously monitors all critical machine functions and system status. The operator's dash includes a user-friendly troubleshooting section for rapid fault identification, increasing the availability and productivity of the machine.

### Machine health monitoring system

The monitoring system and alarm strategy provides a 3-tier warning and shutdown functionality alerting the operator of any abnormalities and automatically limits the machine's functions.



# OPERATOR SAFETY IS OUR PRIORITY.

## Machine isolation

All engine and machine isolation functions are conveniently located on one panel accessible from ground level. Switches have been designed to incorporate the requirement for the site tag in/out machine isolation process.

- » Battery isolation switch.
- » Starter isolation switch.
- » Jump start receptacle.
- » Fire system activation (optional).

## Cabin protective structure

The operator cabin has an integrated Rollover Protective Structure (ROPS) certified to ISO 3471:2008 and Falling Object Protective Structure (FOPS) certified to ISO 3449:2005.

## Speed control

The E15 also features intelligent grade-sensing electronic 'speed control' which utilises the high-capacity electromagnetic driveline retarder, engine speed, and the correct transmission gear to control speed while descending into the mine, hence reducing wear and tear on the service breaks, parts and components. When on flat ground the operator can accelerate over the maximum set speed, but when the accelerator pedal is released, the machine speed will revert to the original maximum speed setting.

## Steering

Full hydraulic controlled steering via opposed cylinders at the oscillating hitch. Secondary emergency steering is also provided as standard. Steering system meets ISO 5010:2007.

Handrails are fitted standard in accordance with ISO 2867:2011. All handrails are painted green and designed for 3-point access to cab and machine.

Service brakes are hydraulic applied wet disc brakes.

Emergency brakes are spring applied hydraulic release at the wheel ends. Braking systems meets ISO 3450:2011.

## Additional safety features

- » Emergency crane stops on the manual control station.
- » Wireless joystick remote.
- » Preset exclusion zones.
- » The stabiliser legs manually pivot and extend featuring levelling sensors.
- » Easy pack up for safe transit.
- » Anti-skid step surfaces.
- » Inertia reel retractable seat belt.
- » Steering frame lock.
- » Electrical wiring segregation from all hydraulic hosing.
- » Ground level access allows safe and convenient servicing to tanks, filters, lubrication points and compartment drains.
- » Fire resistant sheathing on electrical harnesses and fuel lines.
- » Firewall/heatshields.
- » 4 Pole machine isolators (Battery and Starter) for additional protection.
- » Integrated fire suppression systems (optional).
- » Hydraulic hosing covered with burst protection sleeves.
- » Operator presence systems.
- » Door lighting for better step visibility.
- » Window egress cord for ease of cab window removal.
- » Rear view camera.
- » Park brake interlocking.
- » Front jacks operate with a "park" function to enable the operator to safely exit the cabin with the engine operating.
- » Additional cab pressurisation with HEPA filter to comply with ISO 23875:2023.

# DELIVERS POWER, PERFORMANCE AND DURABILITY.

## **C7.1 engine**

The Cat C7.1 uses Caterpillar's breakthrough ACERT™ Technology to meet exhaust emission reduction standards. It features efficient fuel delivery, air management and electronic control for high productivity and exceptional service life.

The C7.1 ACERT Tier 3 engine arrangement rated at 168 kW (228 hp) is standard for regions that may not have Ultra Low Sulphur Fuel or more stringent emission regulations. An optional diesel particulate filter can be fitted.

The C7.1 ACERT Tier 4 Final engine arrangement is available as an option, adhering to EU Stage IV exhaust emission standards. This arrangement rated at 151kW (202 hp).

## **ADEM A4 engine control module**

The ADEM A4 module controls the fuel injector solenoids to monitor fuel injection. It also provides automatic altitude compensation, and will not allow the engine to start until it has oil pressure, acting as cold start protection and a form of pre-lube.

## **Maintenance**

The C7.1 engine reduces costs and downtime with 500-hour oil change intervals. The E15 is equipped with Caterpillar high efficiency oil filters, a design which doubles efficiency without increasing the change interval.

## **Engine protection system**

An engine protection system is fitted that will shut down the engine if low engine oil pressure, low coolant level, or coolant over temperature conditions are experienced.

## **Commonality**

The Caterpillar C7.1 engine is found in several Caterpillar products and applications such as Medium Wheel Loaders, Excavators, Motor Graders, Marine and Industrial services. This means the E15 shares component commonality across many applications, providing the highest level of reliability and durability, as well as superior parts availability worldwide through the Caterpillar Dealer Network.

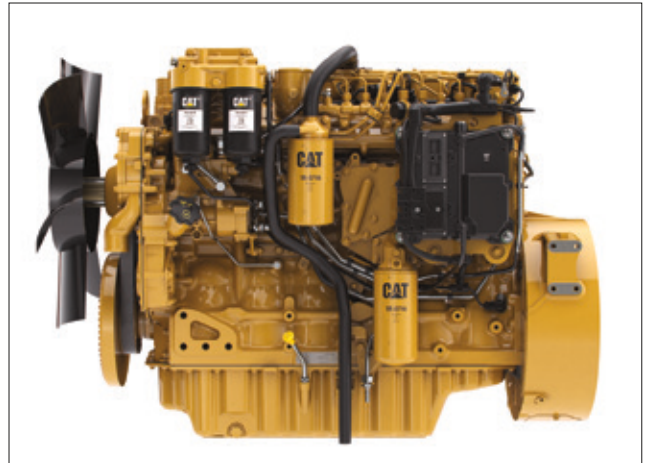



# PERFORMANCE AND RELIABILITY IN TOUGH CONDITIONS.

## **Caterpillar five-speed transmission**

The field proven Cat power shift countershaft transmission easily matches engine power to the load size and ground conditions. Gear changes are simplified with ergonomically positioned electronic fingertip controls, reducing operator fatigue.

## **High-capacity Electromagnetic retarder**

Fitted to the rear frame, the electronically controlled retarder provides superior braking performance on grade, featuring diagnostic capabilities with alarm and fault conditions reported back to the operator display.

The integrated Retarder Control System (iRCS) combines both the control and power functions into a single unit. The innovative electronic design significantly reduces the retarder's energy consumption, preserving electric circuits. The retarder is controlled via an integrated multi-function joystick controller located on the operator's right-side armrest.

## **Reduced shifting**

The multiplication capability of the torque converter reduces the need for the operator to continually shift the transmission. This reduces operator effort and improves machine productivity.

## **All wheel drive (AWD)**

All-wheel drive provides excellent power distribution, increases traction of the machine reducing tire slippage, improving performance, handling and manoeuvrability in tough and challenging terrain.

## **Front and rear axles**

The front axle is rigid mounted design with front suspension available as an option. The rear axle is rigidly mounted to the rear frame.

## **Tyres**

Tyres are an integral part in a machines ability to carry it's load at higher speeds. Fitted with the larger 16:00 R20 radial tires ensures the E15 stays within the tires TKPH limits.

This allows the E15 to carry larger loads at faster speeds than conventional utility equipment.

## **Service brakes**

Hydraulically applied spring release brake system. Brake components are oil immersed inside the axles, protecting them from contamination. Modulated braking provides smooth deceleration for precision stopping and operator control.



## **Parking brake**

The parking brake is a spring applied oil released "fail to safe" enclosed wet disc on all 4-wheel ends.

## **Brake design**

With large discs and plates for reliable, adjustment free operation and performance. Oil cooled disc brakes are completely enclosed to prevent contamination and reduce maintenance.

## **Emergency braking**

When the E15 safety system detects loss of critical drive pressure or brake pressure the operator will receive a warning and then the parking brake system will be safely applied.

## **Load sensing**

A load sensing variable displacement pump and pressure compensating system continually monitor hydraulic power requirements, then provides power based on demand. This improves fuel economy and reduces emissions.

Other features include suction circuits, pump case-drain and steering return, filtered fan/brake pressure circuit, and closed loop hydraulic system.



## FEATURE OVERVIEW

# FLEXIBLE AND SAFE TRANSPORT SOLUTION WITH LIFT ON AND LIFT OFF CAPABILITY.

● Standard ● Optional ● Safety

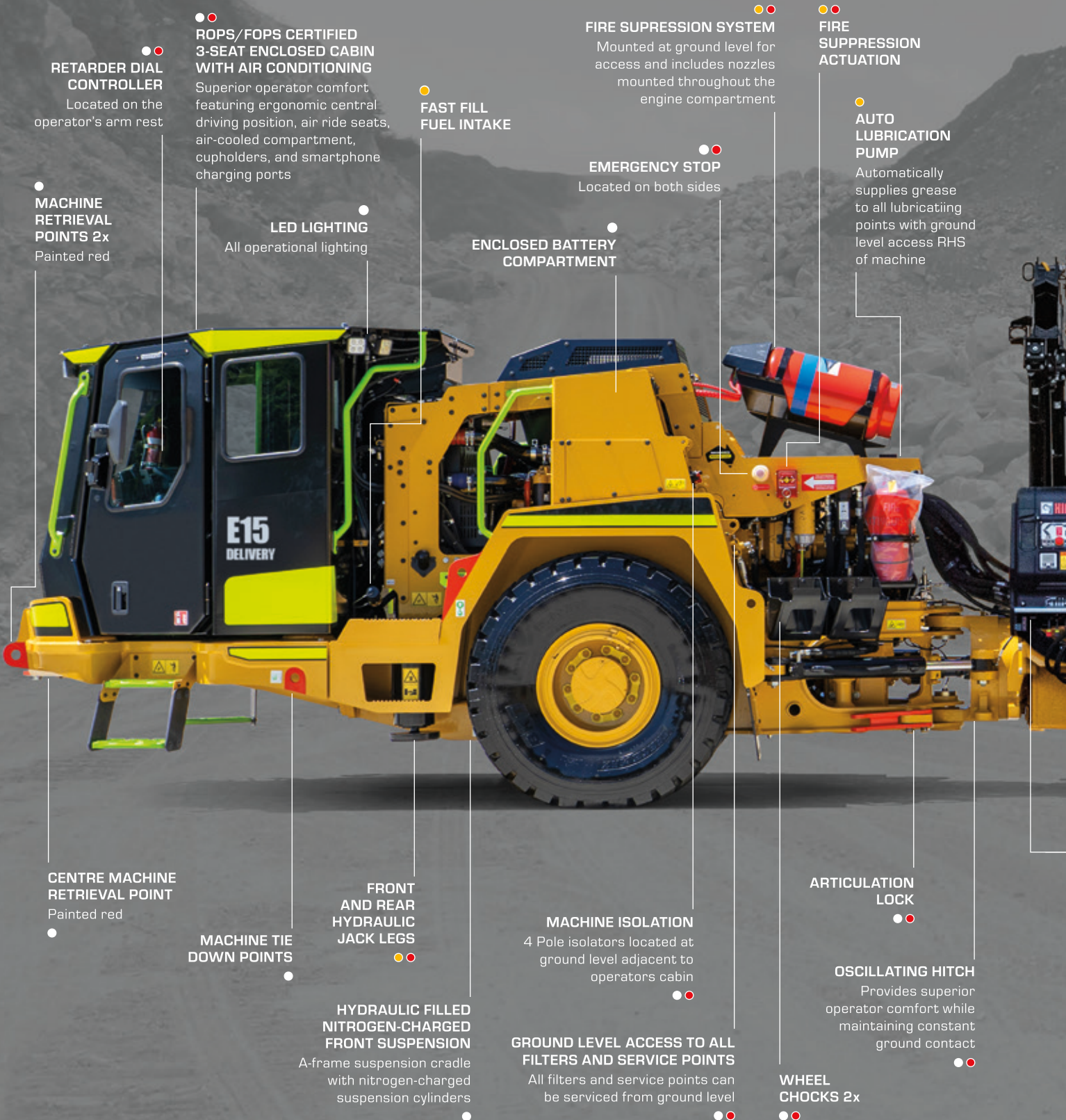

### RETARDER DIAL CONTROLLER

Located on the operator's arm rest

### ROPS/FOPS CERTIFIED 3-SEAT ENCLOSED CABIN WITH AIR CONDITIONING

Superior operator comfort featuring ergonomic central driving position, air ride seats, air-cooled compartment, cupholders, and smartphone charging ports

### FAST FILL FUEL INTAKE

### FIRE SUPPRESSION SYSTEM

Mounted at ground level for access and includes nozzles mounted throughout the engine compartment

### FIRE SUPPRESSION ACTUATION

### AUTO LUBRICATION PUMP

Automatically supplies grease to all lubricating points with ground level access RHS of machine

### MACHINE RETRIEVAL POINTS 2x

Painted red

### LED LIGHTING

All operational lighting

### ENCLOSED BATTERY COMPARTMENT

### EMERGENCY STOP

Located on both sides

### CENTRE MACHINE RETRIEVAL POINT

Painted red

### MACHINE TIE DOWN POINTS

### FRONT AND REAR HYDRAULIC JACK LEGS

### MACHINE ISOLATION

4 Pole isolators located at ground level adjacent to operators cabin

### ARTICULATION LOCK

### OSCILLATING HITCH

Provides superior operator comfort while maintaining constant ground contact

### HYDRAULIC FILLED NITROGEN-CHARGED FRONT SUSPENSION

A-frame suspension cradle with nitrogen-charged suspension cylinders

### GROUND LEVEL ACCESS TO ALL FILTERS AND SERVICE POINTS

All filters and service points can be serviced from ground level

### WHEEL CHOCKS 2x

● **HIAB X-HIDUO 092 CRANE**

Features a rated capacity of 8.8 TM and an outreach of 7.7 metre with preset exclusion zones and manual lever or wireless remote controls

● **HEAVY DUTY HEADBOARD**

Low and high headboard options available depending on the application (optional)

● **MULTIPLE TIE DOWN POINTS**

Includes provision for various ratchet style load binders (optional)

● **EMERGENCY STOP**

Located on both sides

● **4.5M X 2.5M LARGE FLAT DECK WITH UP TO 16,620 KG MAXIMUM PAYLOAD**

Features a steel tread plate floor capable of carrying 6x standard size palettes

● **DUAL-SIDED 3-POINT ACCESS**

Includes high-visibility handrails and heavy grip steps and an optional removable guard rail system that can be stored onboard

● **EASY REMOVABLE HANDRAIL SYSTEM**

Handrails are easily removed using a spring-loaded latch located at ground level near the foot of the post

● **LARGE ENCLOSED ONBOARD STORAGE COMPARTMENT**

Featuring heavy-duty hinges and spring loaded latches

● **STABILISER LEGS WITH LEVELLING SENSORS**

Manually pivot and extend with easy pack up for safe transport

● **GROUND LEVEL CRANE CONTROL STATION**

Features E-stop and manual lever controls

● **LARGE OPEN ONBOARD STORAGE COMPARTMENTS**

Positioned on both sides of the deck at ground level for easy access

● **3-PIECE WHEEL RIMS 16:00 R20 TYRES**

● **FRONT AND REAR HYDRAULIC JACK LEGS**

● **LARGE OPEN ONBOARD STORAGE COMPARTMENTS**

Positioned on both sides of the deck at ground level for easy access

● **REAR MACHINE RETRIEVAL POINTS 2x**

Painted red





# SERVICEABILITY MEANS MORE TIME FOR PRODUCTION.

## Ground-level serviceability

All service points are conveniently located at ground level for servicing. Downtime during maintenance is reduced markedly on the E15 due to clever engineering and design features, incorporated with service personnel in mind.

Quick change air filters and 500-hour oil service intervals reduce downtime and keep machines in operation longer. A centralised onboard service centre includes fast fill, evacuation, and fluid sample points for analysis.

Standard high-visibility green steps and handrails enhance 3-point contact for safe and easy access to the cab, service platform and operation areas.

## Machine Commonality

The Caterpillar C7.1 engine is common to both the E10 and E15 range of underground support vehicles.

The component commonality between the E10, E15 and many other Cat® applications, provides the highest level of reliability and durability, as well as superior parts availability worldwide through Elphinstone and the Cat® Dealer Network.

These factors and more contribute to a reduction in the total cost of operation (TCO), part stocking, and simplified maintenance and operation of the machine.

## Bolt-on guards

Bolt-on guards offer protection to critical components and are easily removable for servicing. All hot components are suitably covered or guarded.

## Electrical system

The 24V electrical system delivers a reliable electrical capacity for engine starting and additional lighting. Wiring circuits are colour coded and numbered for easy diagnosis and repair. All circuits are protected by circuit breakers.

Wiring is double insulated with sealed electrical connectors to prevent moisture and dirt access. Harnesses are covered with fire resistant material for additional protection.

## On-board diagnostic systems

The monitoring system continuously checks all critical machine functions and components and helps locate faults quickly for faster repair.

## Hitch hoses

- » The pilot hoses, pressure line and load sense lines have all been routed above the hitch and bulk-headed for easy hose replacement and fast service.
- » Spin-on oil filters.
- » Spin-on fuel and engine oil filters shorten downtime.
- » Electronic transfer pump eliminates the need to manually prime the fuel system.



## CUSTOMER SUPPORT

# WHEN UPTIME REALLY COUNTS.

### Renowned Cat dealer support

From helping you choose the right machine to financing and ongoing support, your Cat dealer provides the best in sales and service.

- » Manage your costs with preventive maintenance programs like SOS™ fluids analysis, coolant sampling.
- » Stay productive with best-in-class parts availability.
- » Our Cat dealer can also help you boost efficiency with operator training.
- » When it's time for component replacement, your Cat® dealer can help you save even more. Genuine Cat® remanufactured parts carry the same warranty and reliability as new products at savings of 40 to 70 percent for powertrain and hydraulic components.
- » Technical training and maintenance planning are also part of the Dealer offerings.
- » Would you like the dealer to do more? Programs such as Customer Service Agreements (CSA), to a full maintenance and repair contract are available.
- » The E15 Delivery with Crane contains >75% Genuine Cat® Parts.

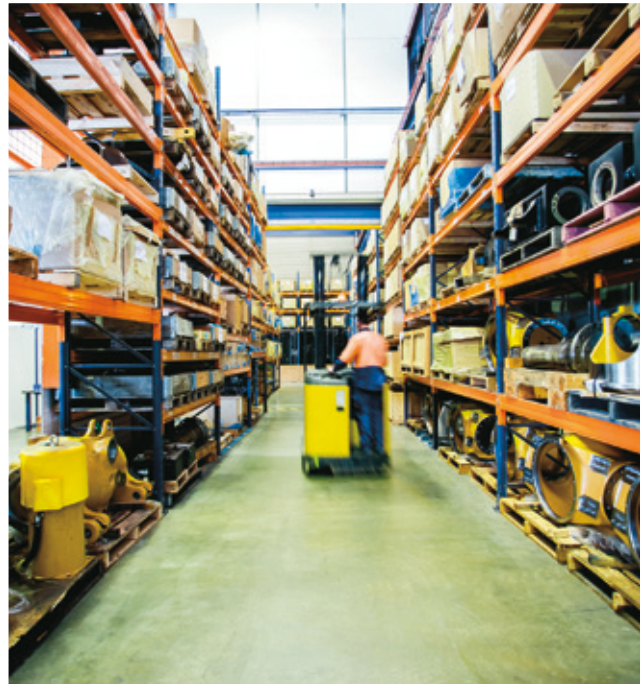

## FUTURE SUSTAINABILITY

# THINKING INTO THE FUTURE.

Elphinstone machines are produced in Tasmania, Australia where our facilities operate on 100% renewable energy.

### Sustainable waste and cost management

- » Integrated machine systems and technologies improve productivity for greater accuracy, lower fuel use and reduce machine wear.
- » Replaceable wear parts save maintenance time and cost and extend major component life.
- » Ecology drains help make draining fluids more convenient and help prevent spills.
- » Major components are built to be rebuilt, eliminating waste and saving customers money by giving the machine and/or major components a second – and even third life rebuilds.
- » A variety of safety features help safeguard operators and others on the job.

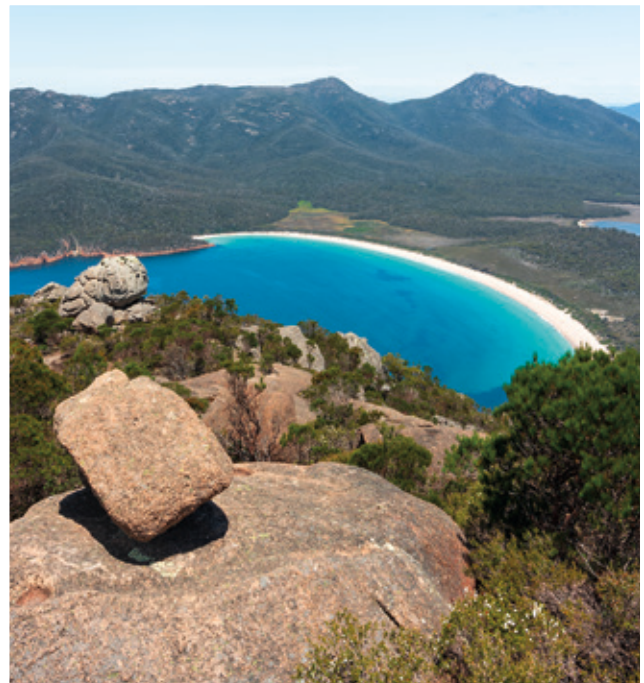



## TECHNICAL SPECIFICATIONS

### Engine

Engine Tier	Tier 3 - Standard		Tier 4 Final (Optional)	
Engine Model	Cat C7.1 ACERT (TA)		Cat C7.1 ACERT (TA)	
Gross Power SAE J1995	168 kW	225 hp	151 kW	202 hp
Displacement	7.0131 L	428 in3	7.0131 L	428 in3
Bore	105 mm	4.1 in	105 mm	4.1 in
Stroke	135 mm	5.3 in	135 mm	5.3 in
Number of Cylinders	6		6	
Max Torque @ Rated Speed	1028 Nm @ 1400 rpm		870 Nm @ 1400 rpm	
Derating Altitude	3000 m	9843 ft	3000 m	9843 ft
Emission Certification	EPA Tier 3		EPA Tier 4 Final	
Alternator	150 amp		150 amp	
Electrical System	24 V		24 V	
Battery - Quantity	2		2	
Battery - Volts	12 V		12 V	
Battery - Capacity	1000CCA		1000CCA	
Starting System	Direct Electric		Direct Electric	

- Power ratings apply at 2200 rpm when tested under the specified standard conditions.
- Based on standard air conditions of 25° C (77° F) and 99 kPa (29.32 in Hg) dry barometer. Used 35° API gravity fuel having an LHV of 42,780 kJ/kg (18,390 BTU/lb) when used at 30° C (860 F) [ref. A fuel density of 838.9 g/L (7.001 lb/gal)].

### Powertrain

Travel Speed - Fwd. 1st	6.2 km/h	3.9 mph
Travel Speed - Fwd. 2nd	10.2 km/h	6.3 mph
Travel Speed - Fwd. 3rd	16.4 km/h	10.2 mph
Travel Speed - Fwd. 4th	21.9 km/h	13.6 mph
Travel Speed - Fwd. 5th	35.1 km/h	21.8 mph
Travel Speed - Rev. 1st	6.2 km/h	3.9 mph
Travel Speed - Rev. 2nd	10.2 km/h	6.3 mph
Travel Speed - Rev. 3rd	21.9 km/h	13.6 mph
Torque Converter Type	Lock-up clutch	
Transmission	5 fwd / 3 rev countershaft powershift	
Steering, Frame Articulation	42.5 degrees	
Brakes - Service Type	Hydraulic applied inboard WET disc enclosed	
Brakes - Parking Type	Internal Spring Applied Hydraulically Released wheel ends (SAHR)	
Tyres	16.00 R20	

### Service Refill

Fuel Tank	340 L	89.8 gal
Cooling System	50 L	13.2 gal
Differential, Final Drive - F	18.5 L	4.9 gal
Differential, Final Drive - R	20.5 L	5.4 gal
Engine Oil	13.5 L	3.6 gal
Transmission, Torque Converter	31 L	8.2 gal
Hydraulic Tank	150 L	39.6 gal
Diesel Exhaust Fluid (DEF) (Tier 4 Final Only)	16 L	4.2 gal

### Speed on Grade

Cat C7.1 ACERT, 168kW Tier 3					
Grade	Vehicle Speed (km/h)				
	1st Fwd	2nd Fwd	3rd Fwd	4th Fwd	5th Fwd
1:7 (14%) Empty (19,240 kg)	6.2	10.2	16.4	16.9	-
1:7 (14%) GVM (35,860 kg)	6.2	9.7	-	-	-
Cat C7.1 ACERT, 151kW Tier 4 Final (High Power)					
Grade	Vehicle Speed (km/h)				
	1st Fwd	2nd Fwd	3rd Fwd	4th Fwd	5th Fwd
1:7 (14%) Empty (19,240 kg)	6.2	10.2	15.7	-	-
1:7 (14%) GVM (35,860 kg)	6.2	8.4	-	-	-

\*Note: 2% rolling resistance

### Weights

Gross Vehicle Weight (GVM)	35,860 kg	79057.8 lb
Tare Weight	19,240 kg	42416.9 lb
HIAB Crane Rated Lift Capacity	8.8 TM	
Maximum Payload	16,620 kg	36640.8 lb

\*Tare weight includes one operator and a full tank of fuel.

### Standards

ROPS/FOPS	ISO 3471:2008 / ISO 3449:2005
Steering	ISO 5010:2007
Braking	ISO 3450-2011/CSA-M424.3-M90
HIAB Crane	AS 1418.11-2014



## MACHINE DIMENSIONS

Turning Radius

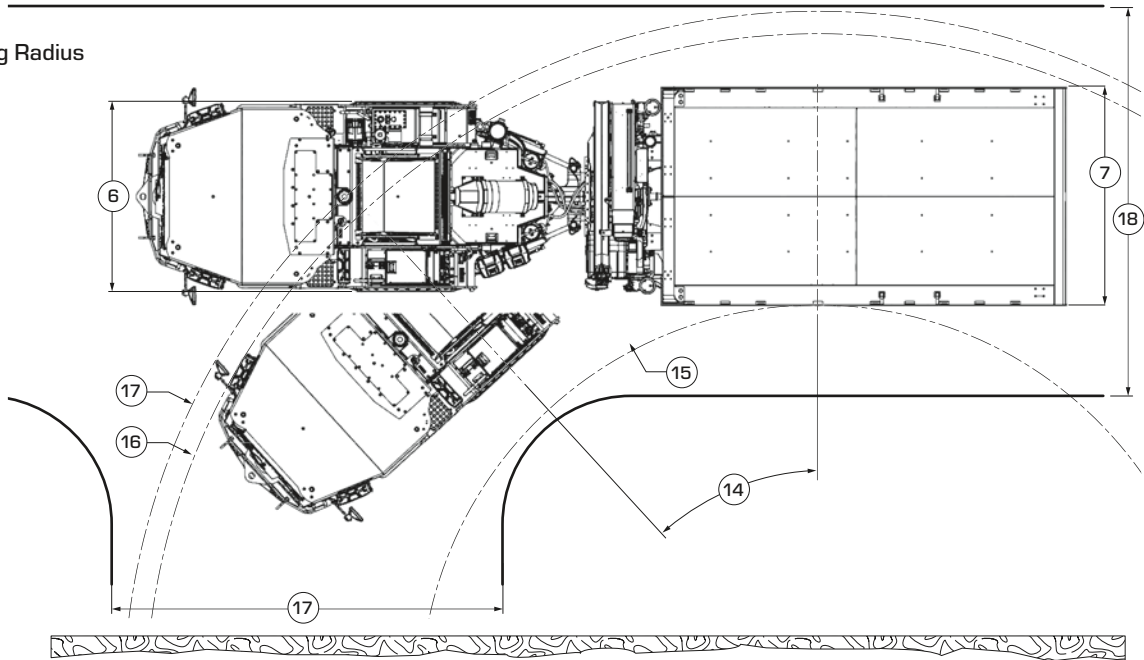

Side View and Drive Size

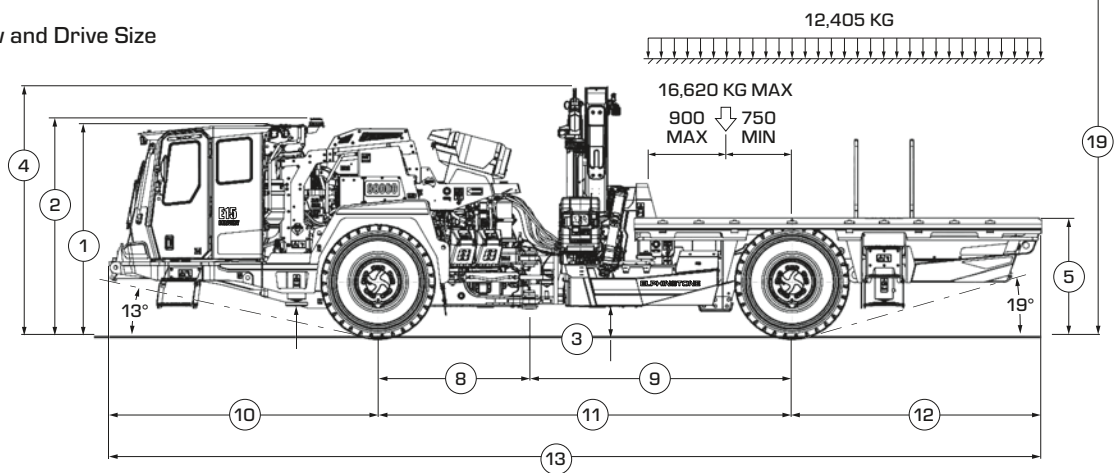

### Dimensions

1	Height - Top of Cabin	2425mm	8 ft 0.3 in
2	Height - Top of Beacon	2490 mm	8 ft 2.0 in
3	Height - Ground Clearance	350 mm	1 ft 1.8 in
4	Height - Top of Knuckle Boom	2870 mm	9 ft 4.9 in
5	Height - Top of Deck	1335 mm	4 ft 4.4 in
6	Width - Machine Front Frame	2180 mm	7 ft 1.8 in
7	Width - Machine Rear Frame	2500 mm	8 ft 2.4 in
8	Length - Front Axle to Hitch	1725 mm	5 ft 7.9 in
9	Length - Hitch to Rear Axle	3000 mm	9 ft 10.1 in
10	Length - Front Axle to Bumper	3090 mm	10 ft 1.8 in
11	Length - Wheel Base	4725 mm	15 ft 6.0 in
12	Length - Rear Axle to Rear Deck	2850 mm	9 ft 4.2 in
13	Length - Overall	10665 mm	34 ft 11.8 in
14	Articulation	42.5 deg	

### Drive Size

15	Radius - Inside Clearance	4575 mm	15 ft
16	Radius - Outside Clearance (Cabin)	7695 mm	25 ft 0.5 in
17	Radius - Outside Clearance (Mirror)	7950 mm	26 ft 0.9 in
18	Minimum Width Portal (90° corner)	4500 mm	14 ft 9.1 in
19	Typical Minimum Height Portal	4500 mm	14 ft 9.1 in



## STANDARD AND OPTIONAL EQUIPMENT

● Standard ● Optional ● Safety

### Powertrain

Air Cleaner, 2-Stage With Integral Pre-Cleaner	●
All Wheel Drive with Lock-up Torque Converter	●
Axle Breathers, Remote Mounted	●
Brakes - Parking, Four Wheel Spring Applied, Enclosed Disc	●
Brakes - Service, Four-Wheel Pressure Applied Enclosed Disc	●
Brake - Driveline, Electromagnetic Retarder	●
Driveline Slip-joint, Lubed for Life	●
Engine, Cat C7.1, ACERT Technology, ATAAC - Tier 3	●
Engine, Cat C7.1, ACERT Technology, ATAAC - Tier 4 Final	●
Fan, Sucker	●
Filters, Engine Air, Primary/Secondary	●
Filters, Fuel, Primary/Secondary	●
Final Drives, Outboard Planetary	●
Fuel Transfer Pump (Electric)	●
Fuel Lines - Double Wire Braided	●
Fuel Shutoff Valves Supply & Return	●
Lock - Wheel Nut (Torque Retention)	●
Muffler/Catalytic Converter (Tier 3 Only)	●
Oscillating Hitch	●
Radiator	●
Steering, Rotary Metering Pump	●
Suspension, Front Axle	●
Transmission, Countershaft Powershift (5F/3R)	●
Universal Joints, Lubed for Life	●
<b>Fast-Fill Systems</b>	
Coolant, Engine Oil, Hydraulic Oil, Transmission Oil	●
Fuel, Non-pressurised	●

### Antifreeze

Coolant, Extended Life for -35°C (-30°F)	●
Coolant, Arctic Extended Life for -50°C (-58°F)	●

### Operator Environment

300 mm (12 in) Touch Screen Operator Display	●
Air-cooled Compartment (for Lunchbox Storage)	●
Brake Retarder Control	●
Cabin, Enclosed, FOPS/ROPS, Climate Control HVAC System	●
Cabin, Pressuriser	●
RESPA Recirculation Filter	●
Camera/Monitor, Reversing	●●
Cupholders	●
Diagnostic Connector	●
Engine Idle Timer	●
Fire Extinguisher 1.5 kg, Hand Held Dry Chemical Powder 3A:40B:E LH and RH Side	●●
Interior Lamps (LED)	●
Mirrors, Rear View	●
Seat Belt, 3x Retractable, Occupancy Indicator	●
Seat, T-Seat, Air Suspension, Operator	●
2x Seat, T-Seat, Air Suspension, Companion	●
Seat Covers, Operator and Companion	●
Steering Wheel, Tilt and Telescoping	●
Device Charging Ports	●

### Operator Environment

<b>Instrumentation, Gauges</b>	
Brake, Accumulator Pressure	●
Brake, Oil Pressure	●
Diesel Exhaust Fluid (DEF) (Tier 4 Final Only)	●
Engine, Coolant Temperature	●
Engine, Oil Pressure	●
Fuel, Level	●
Hydraulic, Oil Temperature	●
Pressuriser Air Filter, High Efficiency Particulate Air	●
Pressuriser Air Filter, Activated Charcoal	●
Speedometer	●
Steering, System Pressure	●
Tachometer	●
Torque Converter, Oil Temperature	●

<b>Instrumentation, Warning Indicators</b>	
Brake, Accumulator Oil Pressure	●
Brake, Fault	●
Brake, Park Indicator	●
Cabin, Door Open	●
Electrical System	●
Emergency Stop	●
Engine, Coolant Temperature	●
Engine, Fault	●
Engine, Oil Pressure	●
Hydraulic, Oil Level	●
Hydraulic, Oil Temperature	●
Steering, Primary	●
Steering, Secondary	●
Torque Converter, Oil Temperature	●
Transmission, Fault	●
Transmission, Oil Filter Bypass	●

<b>Instrumentation, Digital Data</b>	
Gear and Direction	●
Driveline Retarder, Braking Percentage	●
Service Hour, Meter	●

### Electrical

Accessory Power Port (12 V) & (24 V)	●
Alarm, Back-up	●
Alternator, 150 amp	●
Auxiliary Start Receptacle	●
Batteries, Maintenance Free (2x1000 CCA)	●
Battery Isolation, Lockable Disconnect Switch (4 Pole)	●
Emergency Stop - Cabin	●●
Emergency Stop, LH Side Front	●●
Emergency Stop, RH Side Front	●●
Horn, Warning	●
Lights, Beacon (LED), Cab Mounted (Amber/Red/Blue)	●●
Lights, Headlights (LED)	●
Lights, Reversing	●
Lights, Stop/Tail/Turn (LED)	●
Lights, Work, Front/Rear - Cab Mounted (LED)	●



## STANDARD AND OPTIONAL EQUIPMENT

● Standard ● Optional ● Safety

### Electrical

Lights, Work, Front/Rear - Cab Mounted (LED) Additional	●
Product Link, Cellular	●
Radio, Ready, Communications	●
Radio, AM/FM/USB/Bluetooth	●
Sealed Electrical Connectors	●
Starter, Electric, Heavy Duty	●
Starter Isolator, Lockable Disconnect Switch (4 Pole)	●
Starting and Charging System, 24 V	●

### Hydraulics

Case Drain Return Screen	●
Closed Center-load Sensing System	●
Hydraulic Oil Cooler	●
Hydraulic Oil Filling System, Filtered	●
Line Filter, Full Flow Return	●
Suction Screen	●

### Deck and Work Tools

8.8 TM Lift Capacity, Crane	●
2,500 mm Wide x 4,500 mm Long Flat Deck	●
4x Holes to Accommodate Eyebolt Type Tie-down Points	●
12x slots (6 each side) to Accommodate Various Ratchet Style Restraint Systems (Removable Type)	●
3-Point Access System, Both Sides	●
Automatic Speed Control (ASC)	●
HIAB X-HIDUO 092 B2 Telescoping Knuckle Boom Crane	●
Jack Legs, Hydraulic, Front (LH and RH Side)	●
Jack Legs, Hydraulic, Rear (LH and RH Side)	●
Manual Lever Control, Crane	●
Wireless Joystick Remote Control, Crane	●
Ratchet Load Binders	●
Semi Automatic Pack-Up, Crane	●
Tool Box & Storage Compartments Both Sides	●
Stabiliser Legs, Manual Pivot & Extension, Crane	●

### Other

Brakes, Park, Onboard, Release for Machine Retrieval	● ●
Film, GP Reflective, Flourescent Yellow	● ●
Fire Extinguisher, 4.5 kg, Hand Held Dry Chemical Powder 4A:60B:E LH and RH Side	● ●
Fire Extinguisher, 9 kg, Hand Held Dry Chemical Powder 6A:80B:E LH and RH Side	● ●
Fire Suppression System, Ansul A101 Dry Chemical Powder, Engine Shutdown	● ●
Fire Suppression System, Sandvik Aqueous-Film Forming Foam, Engine Shutdown	● ●
Grease Lubrication System, Centralised, Manual	●
Grease Lubrication System, Automatic	●
Lift, Tie Down and Retrieval Points (Front and Rear)	●
Mudguards	●
Radiator, Cap, Manual Pressure Release	●
Scheduled Oil Sampling (SOS) ports	●
Steering, Frame Lock Link	●
Steering, Secondary	●
Tyres, Tubeless Rims (16.00 R20)	●
Tyre and Rim, Spare (16.00 R20)	●
Unit Number Placard	●
Wheel Chocks	● ●





# OVER 50 YEARS IN THE MINING INDUSTRY.

Elphinstone Pty Ltd is an established Caterpillar OEM Solutions customer with over 50 years' experience in the mining industry.

Elphinstone specialises in the design, manufacture and support of quality equipment for the global underground and surface mining industries.

The Elphinstone range of products combines practical design, the latest technology and quality manufacturing to ensure reliable performance.

The current product range includes specialised underground support vehicles, mine extraction devices, extended distance off-highway haulage trucks and water tanks designed to fit Caterpillar 740C, 745C and 745 articulated trucks.

All Elphinstone products, technical assistance, support, and access to spare parts are available through the global Cat® dealer network with additional support from the Elphinstone regional sales and support team.

## E15 DELIVERY WITH CRANE

For more complete information on Elphinstone products, dealer services, and industry solutions, visit [www.elphinstone.com](http://www.elphinstone.com) or contact your local Cat® dealer.

Material and specifications are subject to change without notice. Featured machines in photos may include additional equipment.

Elphinstone and their respective logos, as well as corporate and product identity used herein, are trademarks of Elphinstone and may not be used without permission.

© 2026 Elphinstone. All rights reserved.  
Made in Australia for export.

**ELPHINSTONE**



HM68413-04 (04-2026)